

1A, 2.25MHz Synchronous Step-Down DC/DC Regulator

DESCRIPTION

The EUP3290 is synchronous step-down DC-DC converters optimized for battery powered portable applications. The 2.7V to 5.5V input voltage range makes EUP3290 ideal for powering portable equipment that runs from 1-cell Li-Ion or 3-cell NiMH/NiCD batteries. The device is also suitable to operate from a standard 3.3V or 5V voltage rail.

The EUP3290 operates at 2.25MHz fixed switching frequency allowing the use of small inductors and capacitors to achieve a small solution size. The internal synchronous switch increases efficiency and eliminates the need for an external schottky diode. The EUP3290 has internal soft start and avoids inrush current during startup.

The EUP3290 has a user selectable mode of forced PWM and PFM/PWM mode. The forced PWM mode operation provides the lowest ripple noise and the PFM mode operation provides high efficiency at light loads. The EUP3290 is available in TSOT23-5 and TDFN-6 package. For TDFN-6 package, it provides up to 1A output current.

FEATURES

- High Efficiency Up to 95%
- 2.25MHz Constant Switching Frequency
- 1A Available Load Current
- 30 μ A Typical Quiescent Current
- 2.7V to 5.5V Input Voltage Range
- Adjustable Output Voltage as Low as 0.6V
- No Schottky Diode Required
- Short Circuit and Thermal Protection
- Internal Soft Start Function
- Available in TDFN-6 and TSOT23-5 Packages
- RoHS Compliant and 100% Lead(Pb)-Free Halogen-Free

APPLICATIONS

- SSD Module
- Smart Phones
- Tablet PC
- Portable Media Players
- μ C/ μ P, FPGA and DSP Power
- Plug-in DC/DC Modules for Routers and Switchers

Typical Application Circuit

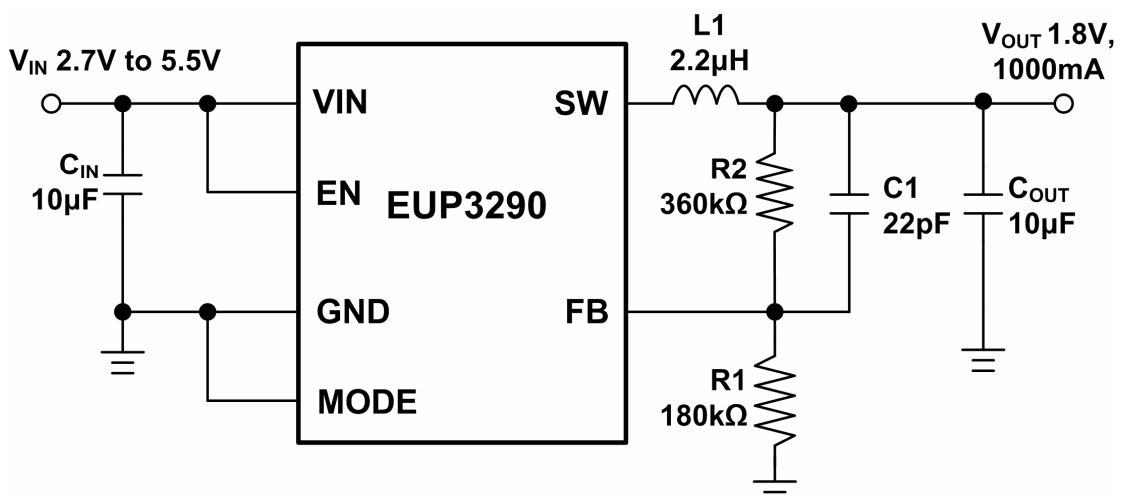

Figure 1.

Pin Configurations

Package Type	Pin Configurations	Package Type	Pin Configurations
TSOT23-5	<p>(TOP VIEW)</p>	TDFN-6	<p>(TOP VIEW)</p>

Pin Description

Name	TSOT23-5	TDFN-6	DESCRIPTION
VIN	1	5	Main Power Supply. Must be closely decoupled to GND.
GND	2	6	Main Ground. Connect to the (-) terminal of output capacitor, and (-) terminal of input capacitor.
EN	3	4	Chip Enable Pin. Forcing this pin to high enables the part, while forcing this pin to low shuts down the device. Do not leave this pin floating.
FB	4	3	Feedback Pin. This pin connects to the feedback resistive network.
SW	5	1	Switch Node Connection to Inductor. This pin connects to the drains of the internal main and synchronous power MOSFET switches.
MODE	-	2	When this pin is tied to high, fixed-frequency PWM mode is selected. When tied to low, PFM/PWM mode is selected. Do not leave this pin floating. For TSOT23-5 package, PFM/PWM mode is selected.

Ordering Information

Order Number	Package Type	Marking	Operating Temperature Range
EUP3290OIR1	TSOT23-5	XXXXX Ay1A	-40°C to +85°C
EUP3290JIR1	TDFN-6	xxx y1A	-40°C to +85°C

EUP3290 □ □ □ □

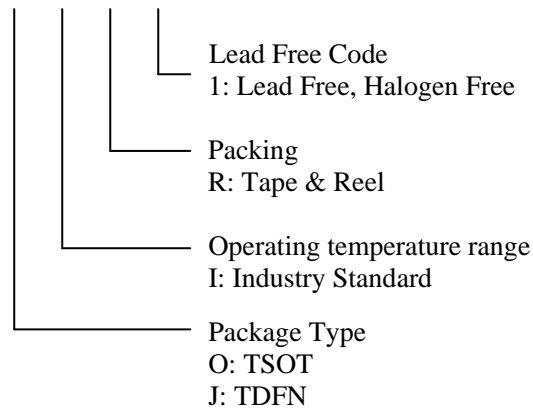

Block Diagram

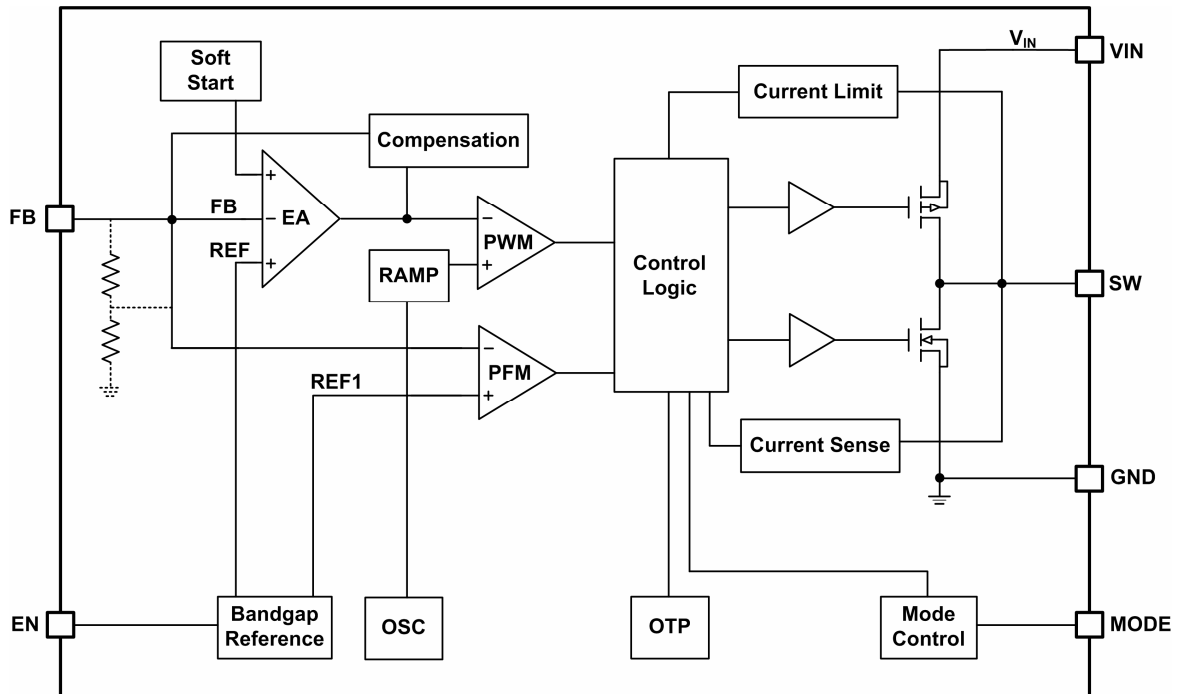

Figure 2.

Absolute Maximum Ratings (1)

- Input Supply Voltage ----- -0.3V to 6V
- EN, SW Voltages ----- -0.3V to $V_{IN} + 0.3V$
- FB, MODE Voltages ----- -0.3V to V_{IN}
- Package Thermal Resistance
 TSOT23-5, θ_{JA} ----- 200°C/W
 TDFN-6, θ_{JA} ----- 70°C/W
- Junction Temperature ----- 125°C
- Storage Temperature ----- -65°C to +150°C
- Lead Temp (Soldering, 10sec) ----- 300°C

Recommended Operating Conditions (2)

- Supply Voltage ----- 2.7V to 5.5V
- Operating Temperature ----- -40°C to +85°C

Note (1): Stress beyond those listed under “Absolute Maximum Ratings” may damage the device.

Note (2): The device is not guaranteed to function outside the recommended operating conditions.

Electrical Characteristics

The ● denote the Spec. apply over the full operating temperature range, otherwise Spec. are $T_A = +25^\circ\text{C}$.

$V_{IN} = 3.6V$ unless otherwise specified.

Symbol	Parameter	Conditions	EUP3290			Unit
			Min.	Typ.	Max.	
V_{IN}	Input Voltage Range	●	2.7		5.5	V
UVLO	Input Undervoltage Lockout	Rising		2.15	2.3	V
UVLO _{Hys}	UVLO Hysteresis			150		mV
I_{FB}	Feedback Current			0		μA
V_{FB}	Regulated Feedback Voltage	$T_A = +25^\circ\text{C}$	0.594	0.6	0.606	V
		$-40^\circ\text{C} \leq T_A \leq +85^\circ\text{C}$	● 0.588	0.6	0.612	V
ΔV_{FB}	Reference Voltage Line Regulation	$V_{IN} = 2.7V$ to 5V		0.2		%/V
ΔV_{OUT}	Output Voltage Load Regulation	$I_{LOAD} = 0$ to 1A, PWM Mode		0.1		%/A
I_Q	Quiescent Current	PWM Mode, Switching with no load, $V_{OUT} = 1.8V$		3.3		mA
		PFM Mode (Note 3), No Switching		30		μA
I_{SHUT}	Shutdown Current	EN=0V		0.1	1	μA
I_{PK}	Peak Inductor Current			3		A
I_{REV}	Reverse Current Limit			1.5		A
f_{OSC}	Oscillator Frequency	●	1.8	2.25	2.7	MHz
R_{PFET}	$R_{DS(ON)}$ of P-Channel FET	$I_{SWX} = 200\text{mA}$		197		m Ω
R_{NFET}	$R_{DS(ON)}$ of N-Channel FET	$I_{SWX} = -200\text{mA}$		216		m Ω
I_{LSW}	SW Leakage Current	EN=0V, SW=0V or 3.6V		0.1	1	μA
V_{EN}	EN Threshold Low	●	0		0.3	V
	EN Threshold High	●	2			V
I_{EN}	EN Leakage Current	●			1	μA
V_{MODE}	MODE Threshold Low		0		0.3	V
	MODE Threshold High		$V_{IN} - 0.5$			V
T_{SD}	Thermal Shutdown			150		$^\circ\text{C}$
T_{SD_Hys}	Thermal Shutdown Hysteresis			20		$^\circ\text{C}$

Note (3): Tested in a proprietary test mode.

Typical Operating Characteristics

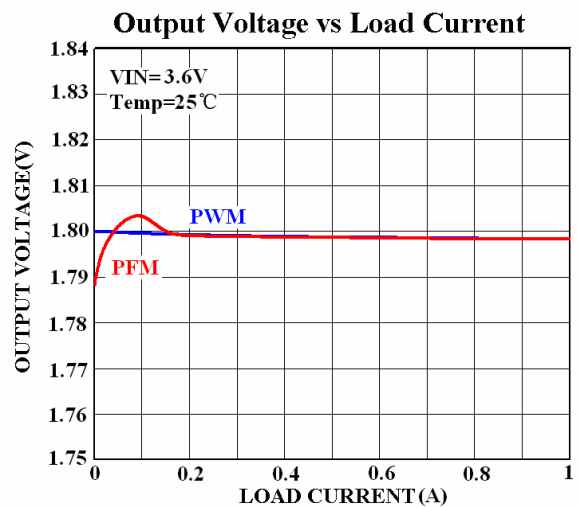
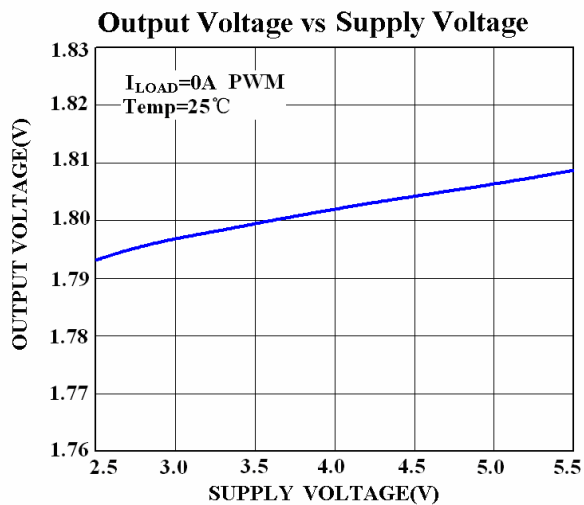
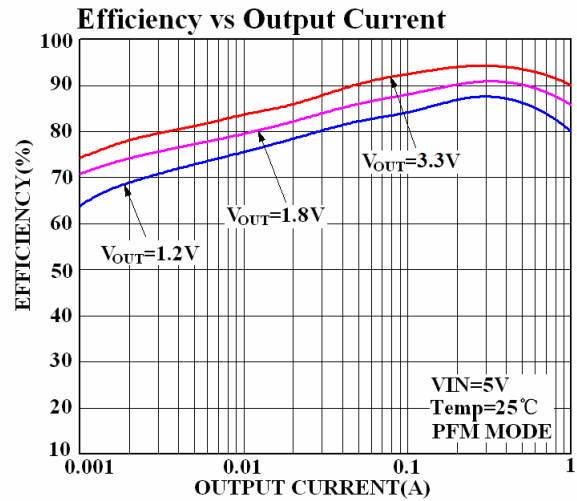
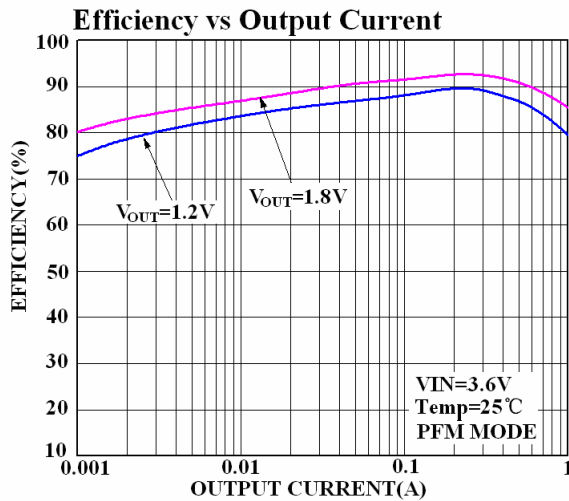
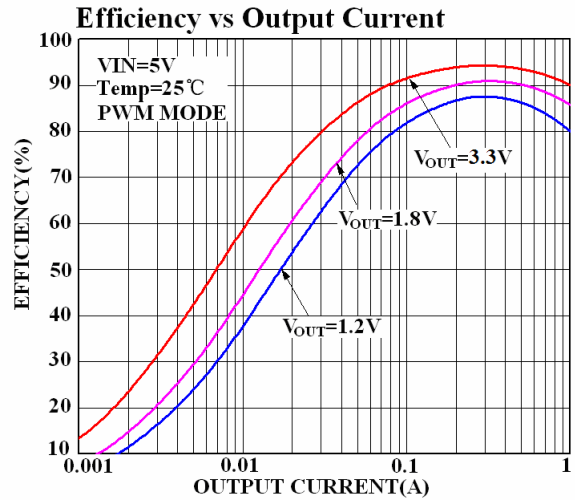
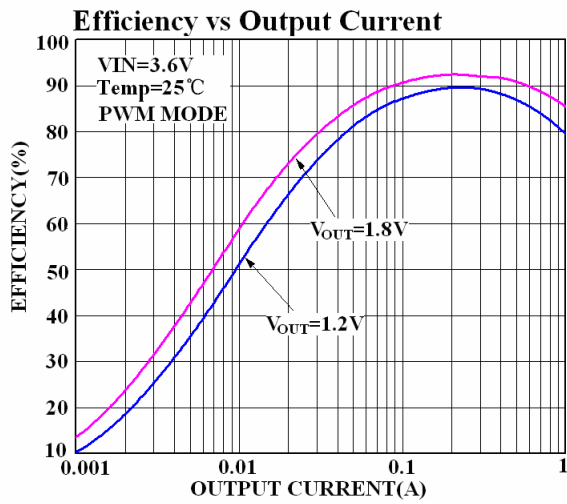

Typical Operating Characteristics (continued)

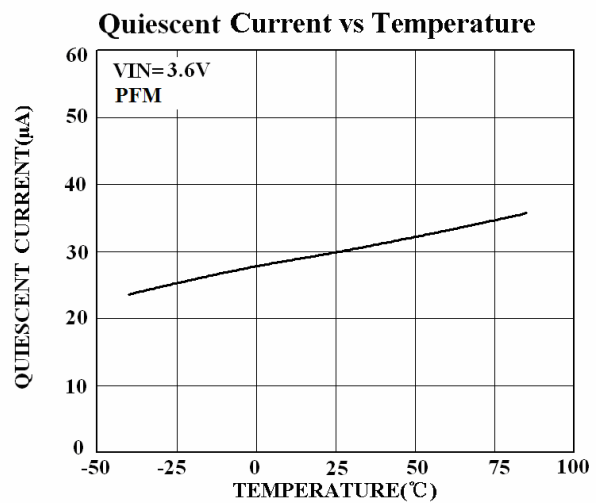
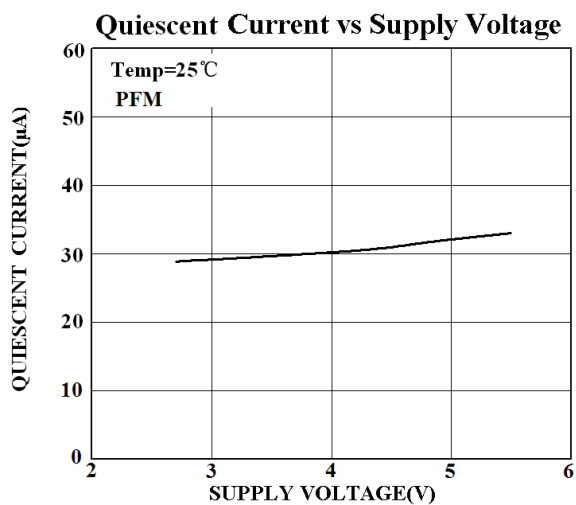
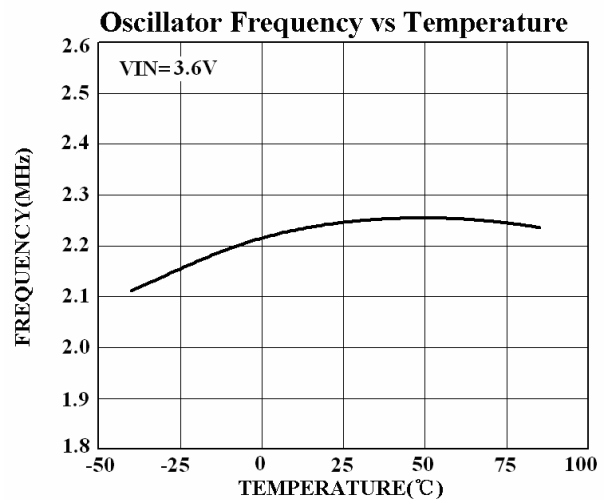
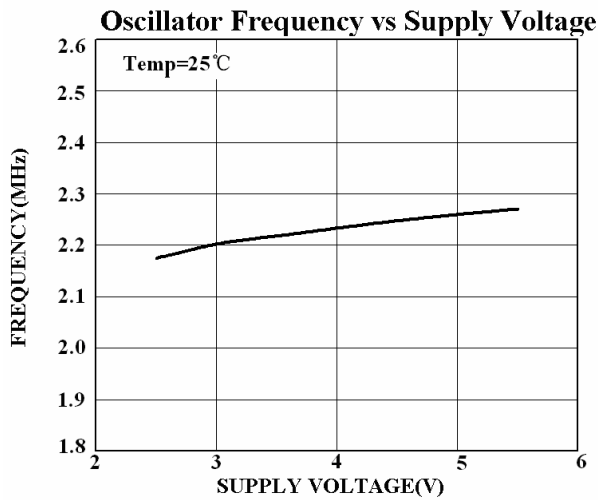
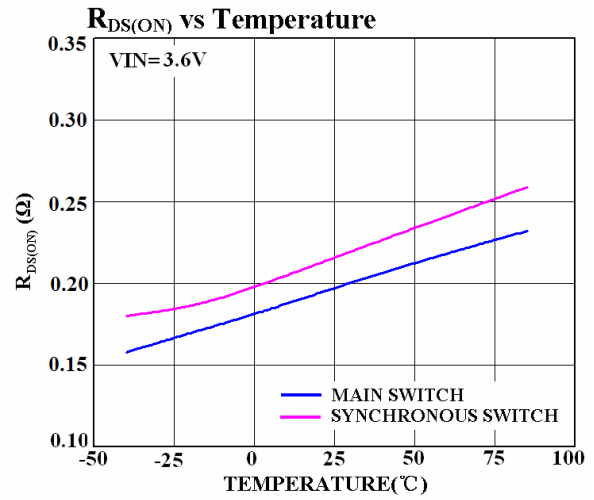
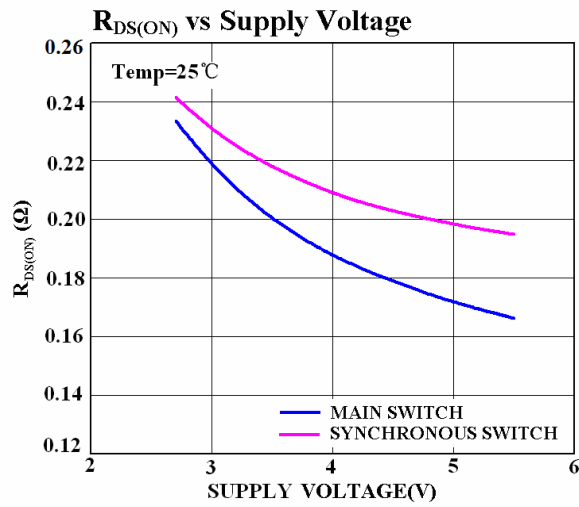

Typical Operating Characteristics (continued)

PWM Operation

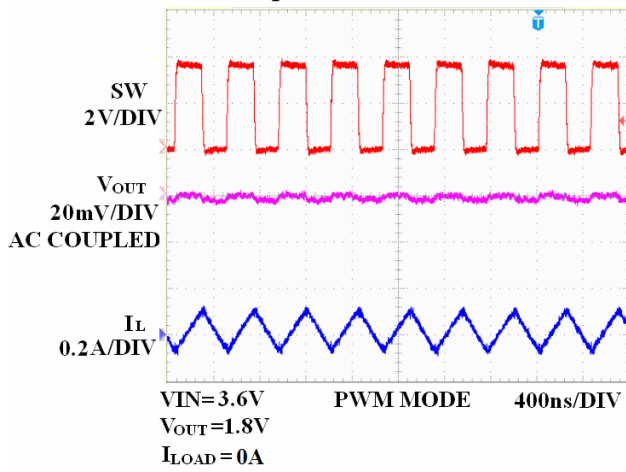

PFM Operation

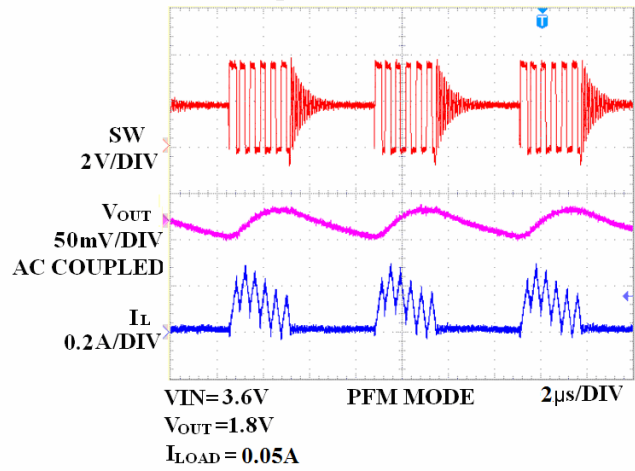

PWM Operation

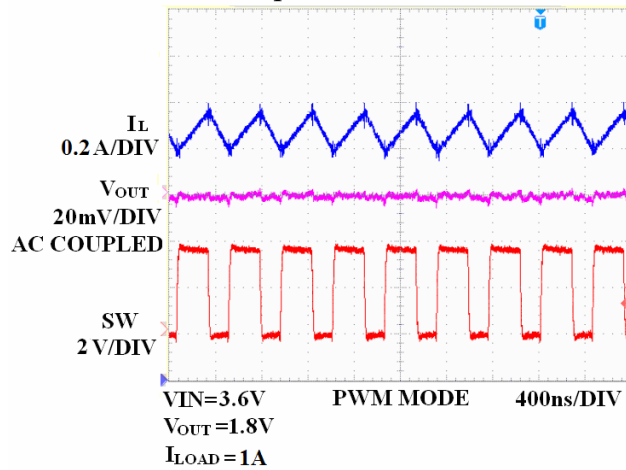

Load Step

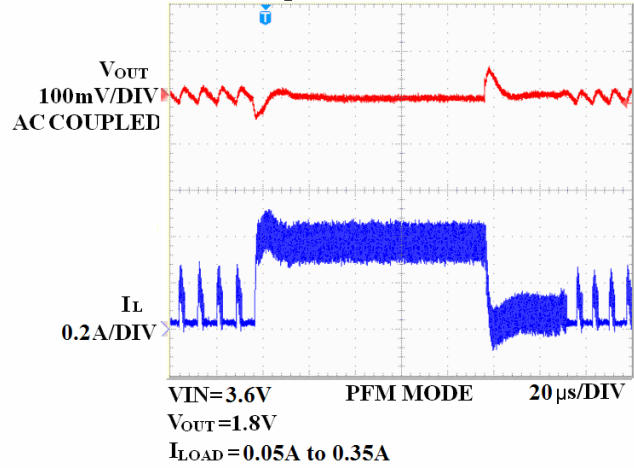

Load Step

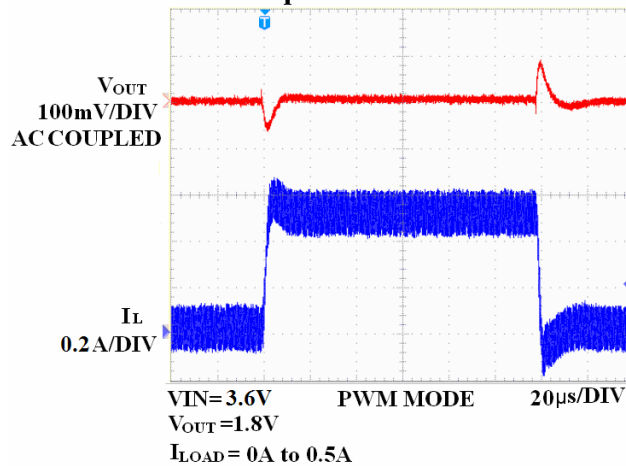

Load Step

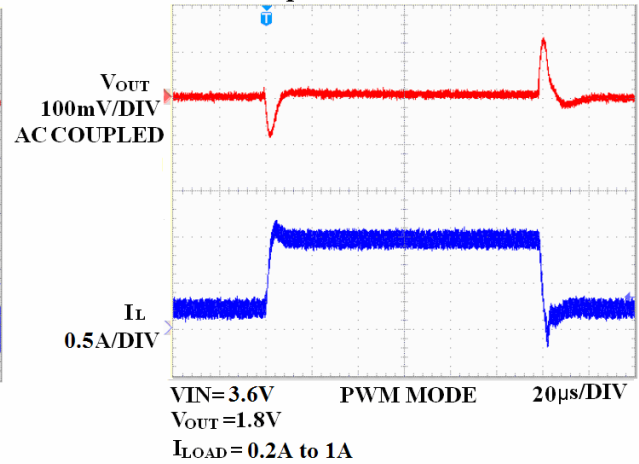

Typical Operating Characteristics (continued)

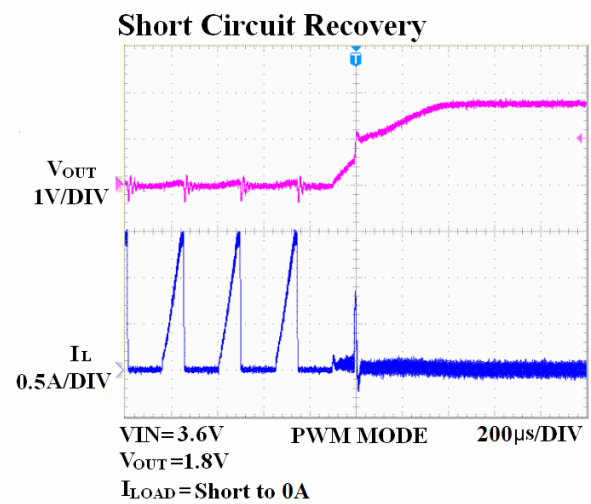
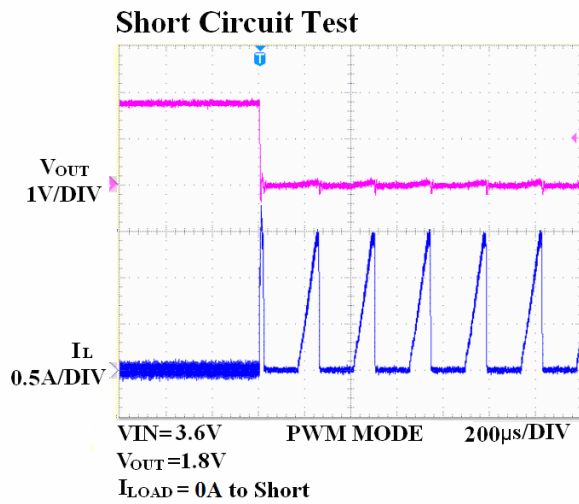
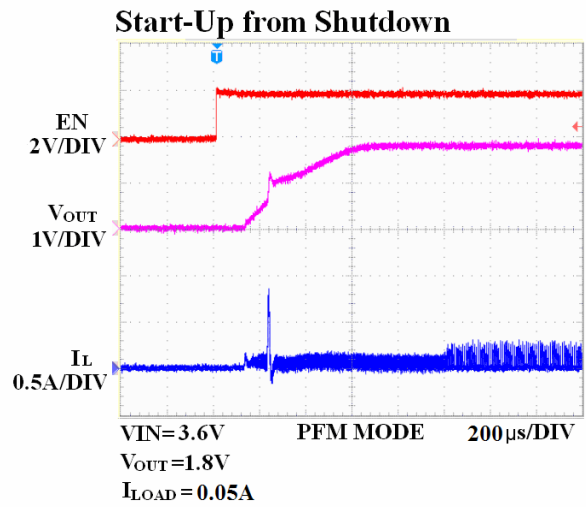
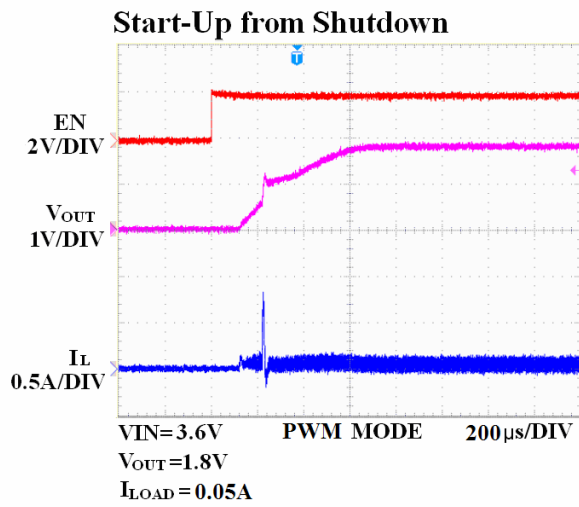

OPERATION

The EUP3290 uses voltage mode architecture with synchronous rectification. Both the main (P-Channel MOSFET) and synchronous (N-channel MOSFET) switches are internal. The operating frequency is set at 2.25MHz. The selectable MODE pin allows the user to trade-off noise for efficiency.

Forced PWM Operation

Pulling MODE pin high selects forced PWM mode. During normal operation, the EUP3290 regulates output voltage by switching at a constant frequency and then modulating the power transferred to the load each cycle using PWM comparator. The duty cycle is controlled by two weighted differential signals: the output of error amplifier and the sawtooth ramp. It modulates output power by adjusting the PFET switch on time during the first half of each cycle. An N-channel, synchronous switch turns on during the second half of each cycle (off time). When the PWM cycle reaches the end of the oscillator period, the synchronous switch turns off. Forced PWM operation provides low ripple noise.

PFM/PWM Operation

Pulling MODE low selects auto mode. The converter will automatically switch between PFM state and PWM state based on load demand. At light loads, the device enters PFM mode and operates with reduced switching frequency and quiescent current to maintain high efficiency. During PFM operation, there are two thresholds to control the loop and limit the output ripple as shown in Figure 3. With the increase of load current, the converter changes from PFM to PWM mode with smooth transition.

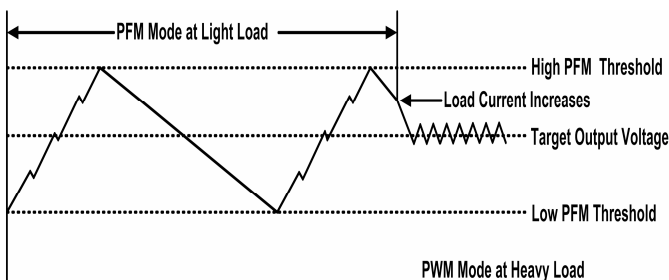

Figure.3 Operation in PFM mode and transfer to PWM mode

Soft Start

The EUP3290 has internal soft-start circuit that limits the inrush current and output overshoot during startup. The generated ramp reference limits the rising speed of inductor current and output voltage.

Input Undervoltage Lockout

The undervoltage lockout circuit prevents device misoperation at low input voltages. It prevents the converter from turning on the main and synchronous switches under undervoltage state.

APPLICATIONS INFORMATION

Inductor Selection

The EUP3290 typically uses a 2.2μH inductor. The output inductor is selected to limit the ripple current to some predetermined value, typically 20%~40% of the full load current at the maximum input voltage. Large value inductors lower ripple currents. Higher V_{IN} or V_{OUT} also increases the ripple current as shown in equation.

$$\Delta I_L = \frac{1}{(f)(L)} V_{OUT} \left(1 - \frac{V_{OUT}}{V_{IN}} \right)$$

The DC current rating of the inductor should be at least equal to the maximum load current plus half the ripple current to prevent core saturation. The DC resistance of the inductor directly influences the efficiency of the converter. Therefore for better efficiency, choose a low DC-resistance inductor.

C_{IN} and C_{OUT} Selection

In continuous mode, the source current of the top MOSFET is a square wave of duty cycle V_{OUT}/V_{IN} . The primary function of the input capacitor is to provide a low impedance loop for the edges of pulsed current drawn by the EUP3290. A low ESR input capacitor sized for the maximum RMS current must be used. The size required will vary depending on the load, output voltage and input voltage source impedance characteristics. A typically C_{IN} value is around 10μF. If the wire of supply is too long, larger input capacitor should be used.

The input capacitor RMS current varies with the input voltage and the output voltage. The equation for the maximum RMS current in the input capacitor is:

$$I_{RMS} = I_O \times \sqrt{\frac{V_O}{V_{IN}} \times \left(1 - \frac{V_O}{V_{IN}} \right)}$$

The output capacitor C_{OUT} has a strong effect on loop stability.

The selection of C_{OUT} is driven by the required effective series resistance (ESR). ESR is a direct function of the volume of the capacitor; that is, physically larger capacitors have lower ESR. Once the ESR requirement for C_{OUT} has been met, the RMS current rating generally far exceeds the $I_{RIPPLE(P-P)}$ requirement. The output ripple ΔV_{OUT} in PWM mode is determined by:

$$\Delta V_{OUT} \cong \Delta I_L \left(ESR + \frac{1}{8fC_{OUT}} \right)$$

In some cases, 0.1μF to 1μF of ceramic capacitors should also be placed closed to EUP3290 in parallel with the main capacitors for high frequency decoupling. When choosing the input and output ceramic capacitors, choose the X5R or X7R dielectric formulations. These dielectrics have the best temperature and voltage characteristics of all the ceramics for a given value and size.

Output Voltage Programming

For adjustable version, the output voltage is set by a resistive divider according to the following formula:

$$V_{OUT} = 0.6V \left(1 + \frac{R2}{R1} \right)$$

The external resistive divider is connected to the output, allowing remote voltage sensing as shown in Figure 4.

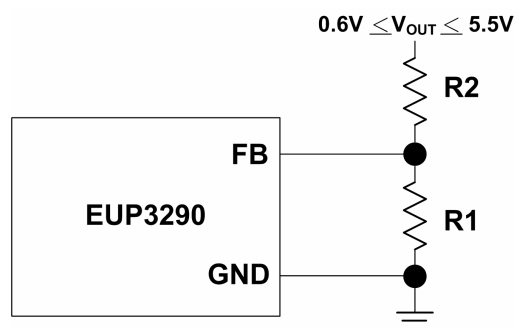

Figure 4. Setting the EUP3290 Output Voltage

Thermal Considerations

To avoid the EUP3290 from exceeding the maximum junction temperature, the user will need to do a thermal analysis. The goal of the thermal analysis is to determine whether the operating conditions exceed the maximum junction temperature of the part. The temperature rise is given by:

$$T_R = (P_D)(\theta_{JA})$$

Where $P_D = I_{LOAD}^2 \times R_{DS(ON)}$ is the power dissipated by the regulator ; θ_{JA} is the thermal resistance from the junction of the die to the ambient temperature.

The junction temperature, T_J , is given by:

$$T_J = T_A + T_R$$

Where T_A is the ambient temperature.

T_J should be below the maximum junction temperature of 125°C.

PC Board Layout Checklist

When laying out the printed circuit board, the following guidelines should be used to ensure proper operation of the EUP3290.

1. The input capacitor C_{IN} should connect to VIN as closely as possible. This capacitor provides the AC current to the internal power MOSFETs.
2. The power traces, consisting of the GND trace, the SW trace and the VIN trace should be kept short, direct and wide.
3. The FB pin should connect directly to the feedback resistors. The resistive divider R1/R2 must be connected between the C_{OUT} and ground.
4. Keep the switching node, SW, away from the sensitive FB node.
5. For good thermal coupling, PCB vias are required from the Pad for the TDFN paddle to the ground plane.

Packaging Information

TSOT23-5

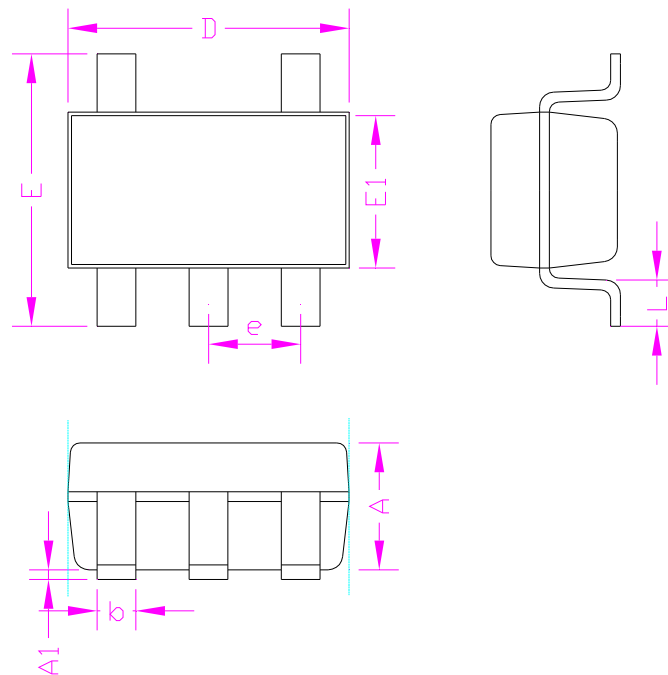

SYMBOLS	MILLIMETERS			INCHES		
	MIN.	Normal	MAX.	MIN.	Normal	MAX.
A	-	-	1.00	-	-	0.039
A1	0.00	-	0.15	0.000	-	0.006
D	2.65	2.90	3.15	0.104	0.114	0.124
E1	1.40	1.60	1.80	0.055	0.063	0.071
E	2.60	2.80	3.00	0.102	0.110	0.118
L	0.30	0.45	0.60	0.012	0.018	0.024
b	0.30	-	0.55	0.012	-	0.020
e	0.95 REF			0.037 REF		

TDFN-6

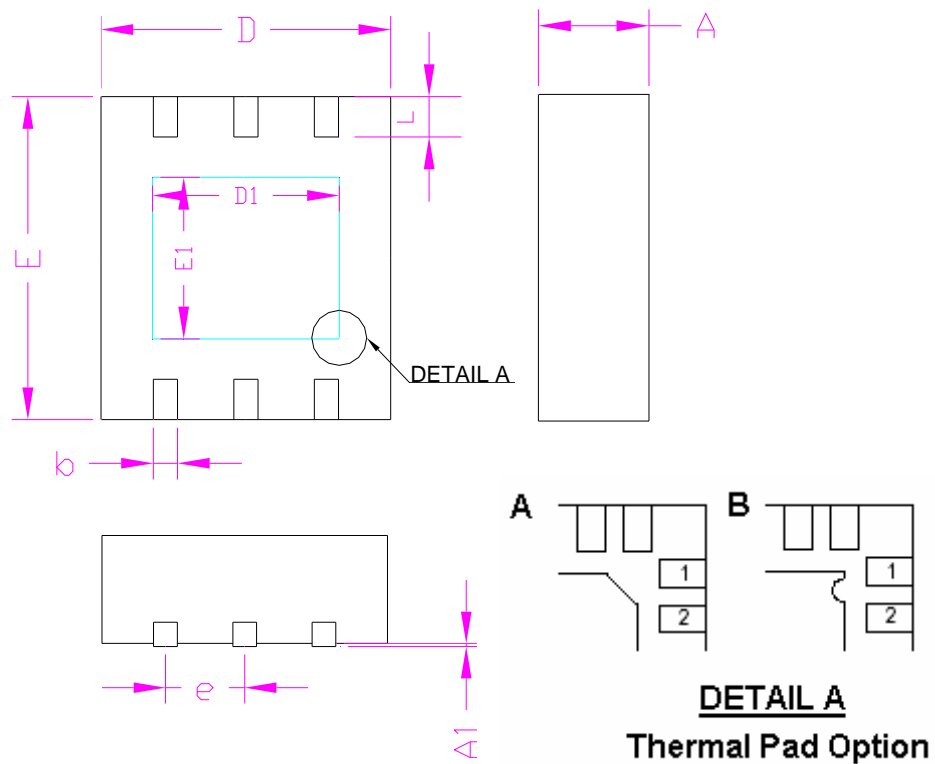

SYMBOLS	MILLIMETERS			INCHES		
	MIN.	Normal	MAX.	MIN.	Normal	MAX.
A	0.70	0.75	0.80	0.028	0.030	0.032
A1	0.00	-	0.05	0.000	-	0.002
b	0.20	0.30	0.40	0.008	0.012	0.016
D	1.90	2.00	2.10	0.075	0.079	0.083
D1	1.30	1.40	1.65	0.051	0.055	0.065
E	1.90	2.00	2.10	0.075	0.079	0.083
E1	0.60	0.80	0.90	0.024	0.032	0.035
e	0.65 REF			0.026 REF		
L	0.25	0.35	0.45	0.010	0.014	0.018