

## N-Channel Enhancement Mode Power MOSFET

### Description

The BLM2010E uses advanced trench technology to provide excellent  $R_{DS(ON)}$ , low gate charge and operation with gate voltages as low as 2.5V. This device is suitable for use as a load switch or in PWM applications. It is ESD protected.

### General Features

- $V_{DS} = 20V, I_D = 7A$
- $R_{DS(ON)} < 27m\Omega @ V_{GS}=2.5V$
- $R_{DS(ON)} < 21m\Omega @ V_{GS}=4.5V$
- ESD Rating: 2000V HBM
- High Power and current handling capability
- Lead free product is acquired
- Surface Mount Package

### Application

- PWM application
- Load switch

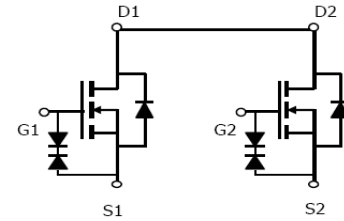

Schematic diagram



Marking and pin Assignment



TSSOP-8 top view

### Package Marking And Ordering Information

Device Marking	Device	Device Package	Reel Size	Tape width	Quantity
2010E	BLM2010E	TSSOP-8	Ø330mm	12mm	3000 units

### Absolute Maximum Ratings (TA=25°C unless otherwise noted)

Parameter	Symbol	Limit	Unit
Drain-Source Voltage	$V_{DS}$	20	V
Gate-Source Voltage	$V_{GS}$	±12	V
Drain Current-Continuous	$I_D$	7	A
Drain Current-Pulsed (Note 1)	$I_{DM}$	30	A
Maximum Power Dissipation	$P_D$	1.5	W
Operating Junction and Storage Temperature Range	$T_J, T_{STG}$	-55 To 150	°C

### Thermal Characteristic

Thermal Resistance, Junction-to-Ambient (Note 2)	$R_{\theta JA}$	83.3	°C/W
--	-----------------	------	------

### Electrical Characteristics (TA=25°C unless otherwise noted)

Parameter	Symbol	Condition	Min	Typ	Max	Unit
<b>Off Characteristics</b>						
Drain-Source Breakdown Voltage	$BV_{DSS}$	$V_{GS}=0V, I_D=250\mu A$	20		-	V
Zero Gate Voltage Drain Current	$I_{DSS}$	$V_{DS}=20V, V_{GS}=0V$	-	-	1	μA

Gate-Body Leakage Current	$I_{GSS}$	$V_{GS}=\pm 10V, V_{DS}=0V$	-	-	$\pm 10$	$\mu A$
<b>On Characteristics (Note 3)</b>						
Gate Threshold Voltage	$V_{GS(th)}$	$V_{DS}=V_{GS}, I_D=250\mu A$	0.55	0.7	0.95	V
Drain-Source On-State Resistance	$R_{DS(ON)}$	$V_{GS}=4.5V, I_D=6.5A$	-	15	21	m $\Omega$
		$V_{GS}=2.5V, I_D=5.5A$	-	20	27	m $\Omega$
Forward Transconductance	$g_{FS}$	$V_{DS}=5V, I_D=7A$	-	20	-	S
<b>Dynamic Characteristics (Note4)</b>						
Input Capacitance	$C_{iss}$	$V_{DS}=10V, V_{GS}=0V,$ $F=1.0MHz$	-	1150	-	PF
Output Capacitance	$C_{oss}$		-	185	-	PF
Reverse Transfer Capacitance	$C_{rss}$		-	145	-	PF
<b>Switching Characteristics (Note 4)</b>						
Turn-on Delay Time	$t_{d(on)}$	$V_{DD}=10V, R_L=1.35\Omega$ $V_{GS}=5V, R_{GEN}=3\Omega$	-	6		nS
Turn-on Rise Time	$t_r$		-	13		nS
Turn-Off Delay Time	$t_{d(off)}$		-	52		nS
Turn-Off Fall Time	$t_f$		-	16		nS
Total Gate Charge	$Q_g$	$V_{DS}=10V, I_D=7A,$ $V_{GS}=4.5V$	-	15		nC
Gate-Source Charge	$Q_{gs}$		-	0.8	-	nC
Gate-Drain Charge	$Q_{gd}$		-	3.2	-	nC
<b>Drain-Source Diode Characteristics</b>						
Diode Forward Voltage (Note 3)	$V_{SD}$	$V_{GS}=0V, I_S=1A$	-	-	1.2	V
Diode Forward Current (Note 2)	$I_S$		-	-	7	A

**Notes:**

1. Repetitive Rating: Pulse width limited by maximum junction temperature.
2. Surface Mounted on FR4 Board,  $t \leq 10$  sec.
3. Pulse Test: Pulse Width  $\leq 300\mu s$ , Duty Cycle  $\leq 2\%$ .
4. Guaranteed by design, not subject to production

TYPICAL ELECTRICAL AND THERMAL CHARACTERISTICS

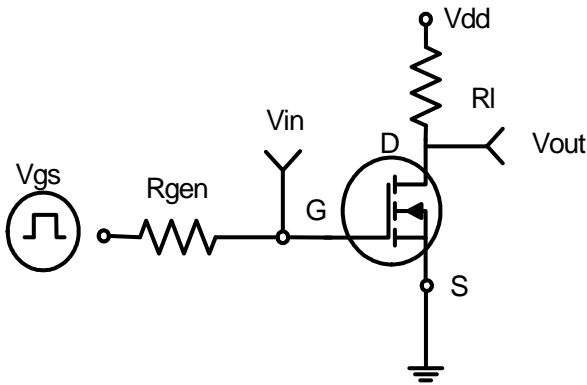

Figure 1: Switching Test Circuit

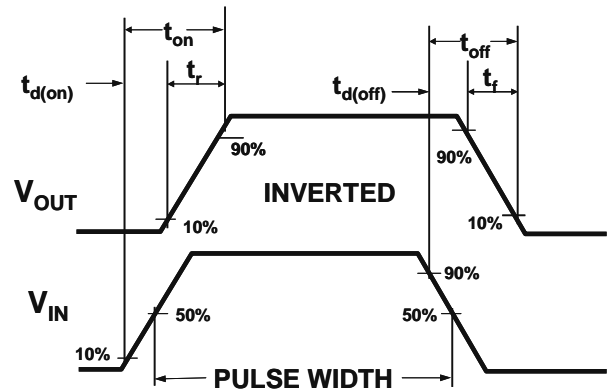

Figure 2: Switching Waveforms

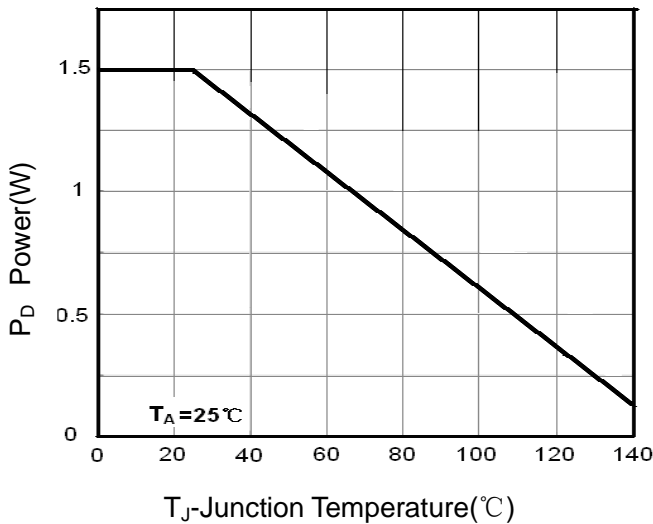

Figure 3 Power Dissipation

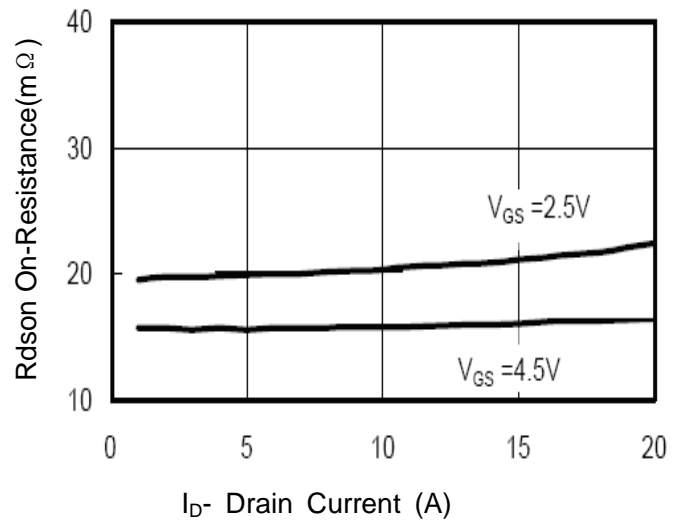

Figure 6 Drain-Source On-Resistance

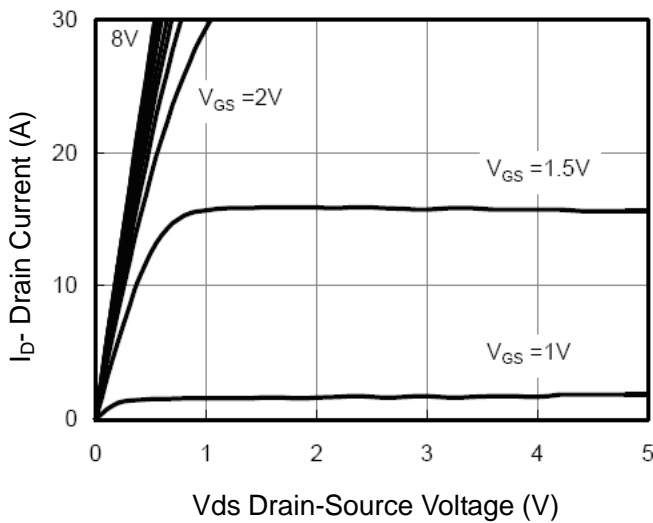

Figure 5 Output CHARACTERISTICS

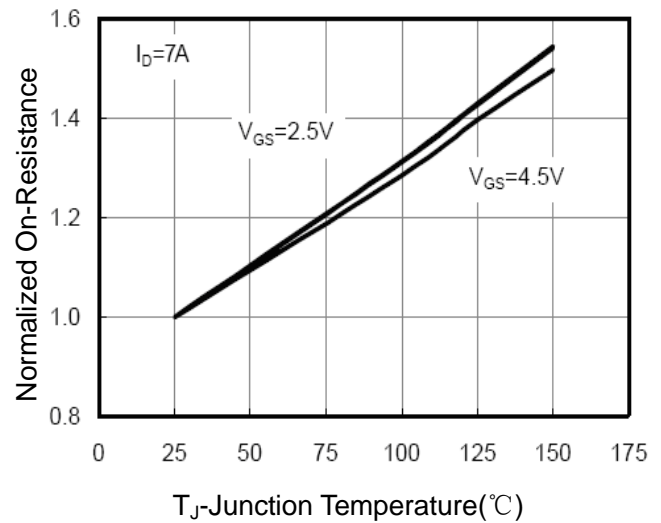
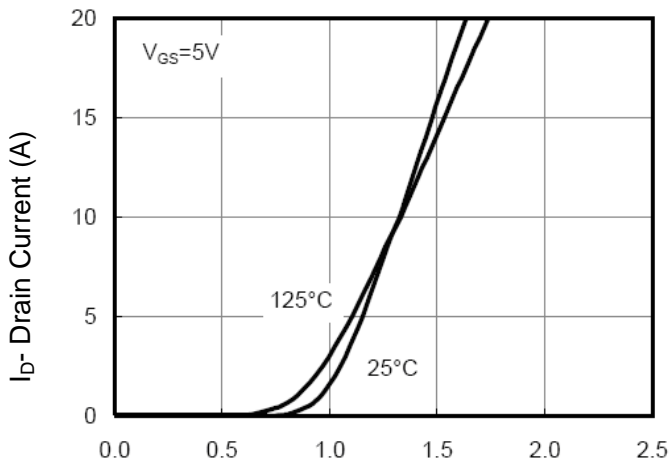
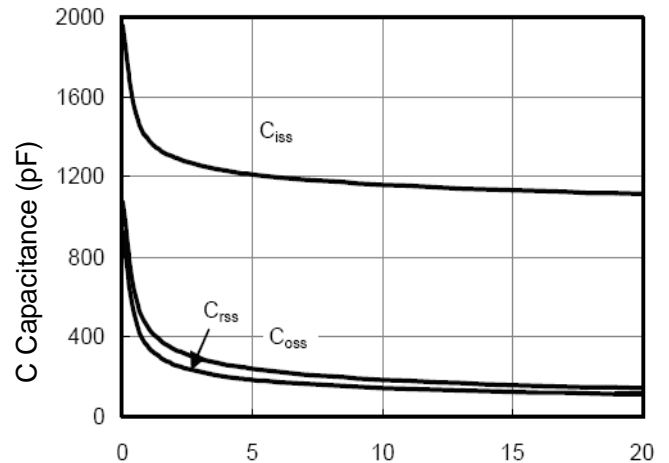

Figure 8 Drain-Source On-Resistance



Vgs Gate-Source Voltage (V)  
**Figure 7 Transfer Characteristics**



Vds Drain-Source Voltage (V)  
**Figure 8 Capacitance vs Vds**

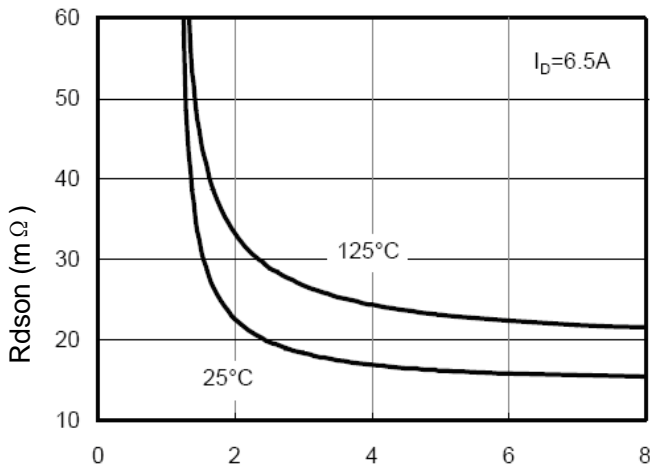

Vgs Gate-Source Voltage (V)  
**Figure 9 Rdson vs Vgs**

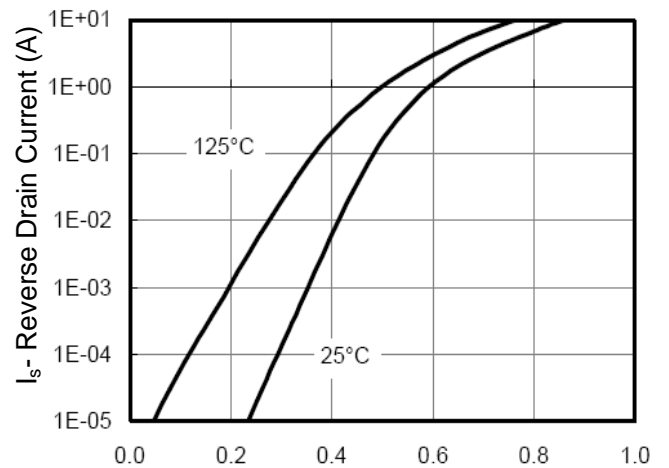

Vds Drain-Source Voltage (V)  
**Figure 10 Capacitance vs Vds**

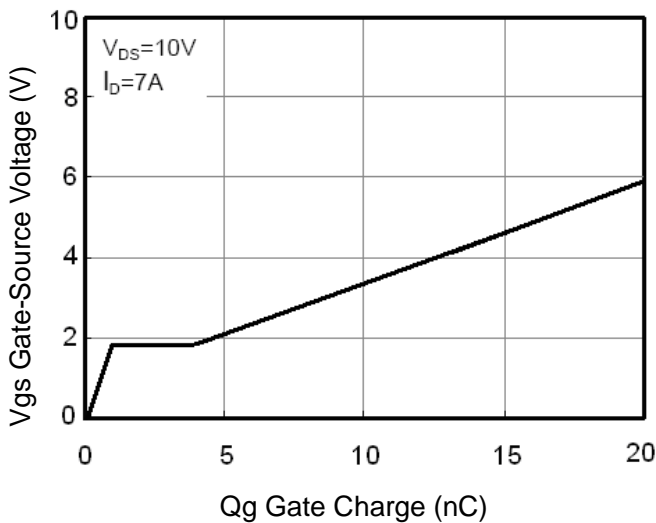

**Figure 11 Gate Charge**

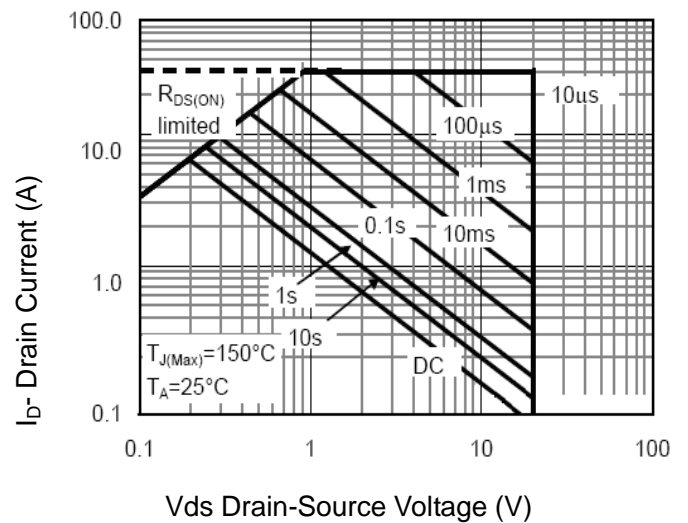

**Figure 13 Safe Operation Area**

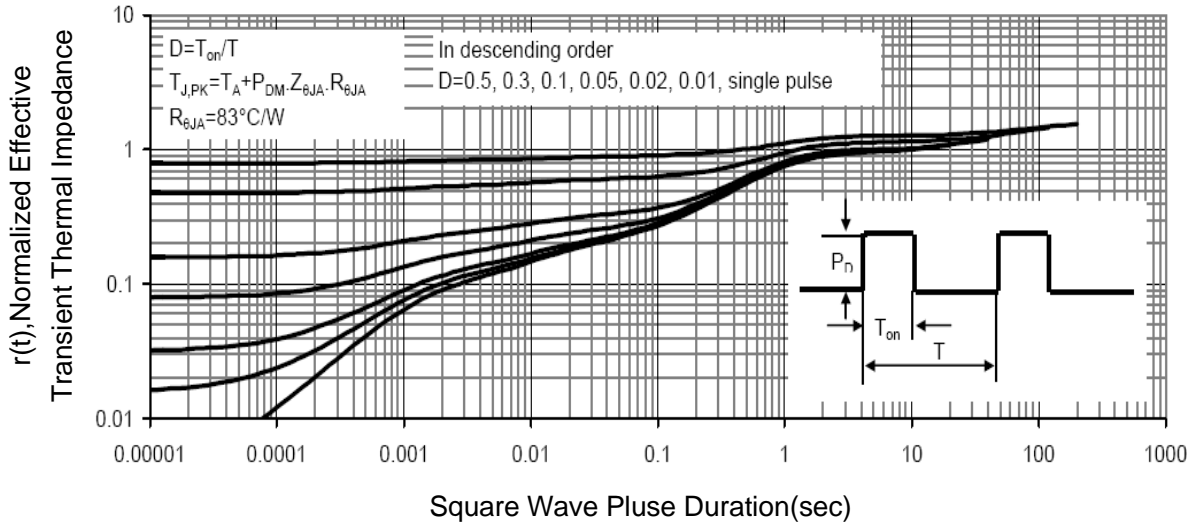

**Figure 14 Normalized Maximum Transient Thermal Impedance**

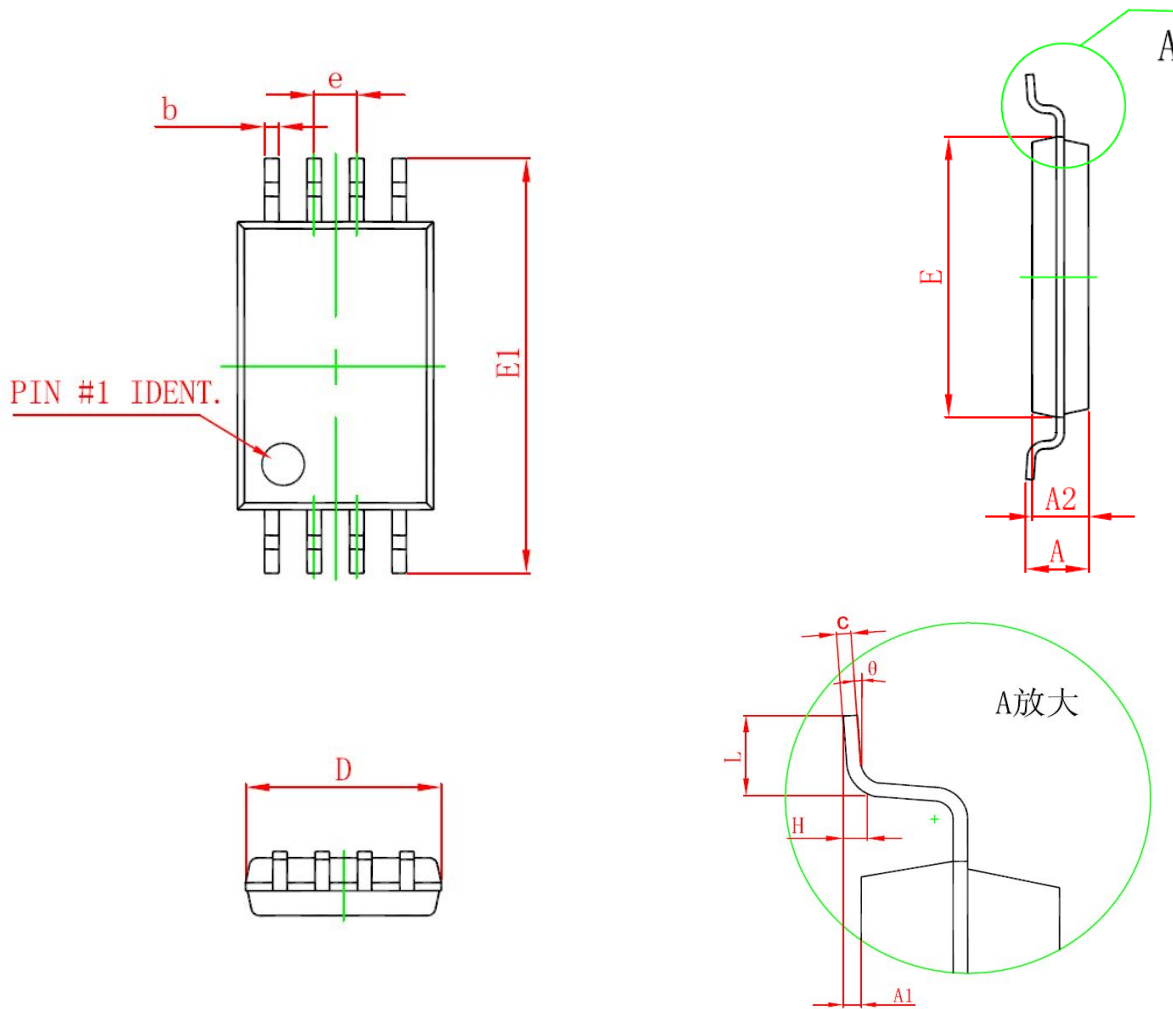
**TSSOP-8 PACKAGE INFORMATION**

Symbol	Dimensions In Millimeters	
	Min	Max
D	2.900	3.100
E	4.300	4.500
b	0.190	0.300
c	0.090	0.200
E1	6.250	6.550
A		1.100
A2	0.800	1.000
A1	0.020	0.150
e	0.65(BSC)	
L	0.500	0.700
H	0.25(TYP)	
θ	1°	7°