

AirMatrix® Surface Mount Fuses

AF Series, 1206 Size



Features:

- Fast acting at 250% overload current level
- Excellent inrush current withstanding capability
- Extremely thin body for space saving
- Much safer with wire-in-air design
- Fiberglass enforced epoxy fuse body
- Copper termination with nickel and tin plating
- Operating temperature range: -55°C to +125 °C (with de-rating)
- 100% lead-free

Application Fields:

- Notebook, Ultrabook
- Backlight Driver
- DC/DC Converter
- Low voltage lighting power
- Automotive electronics

Shape and Dimensions:

Unit	Inch	mm
L	0.126 ± 0.008	3.20 ± 0.20
W	0.063 + 0.012 / -0.004	1.60 + 0.30 / -0.20
T	0.042 ± 0.006	1.08 ± 0.15
B	0.033 ± 0.012	0.85 ± 0.30

Clearing Time Characteristics:

% of Current Rating	Clearing Time at 25°C	
	Min.	Max.
100%	4 hour	
250%		5 seconds

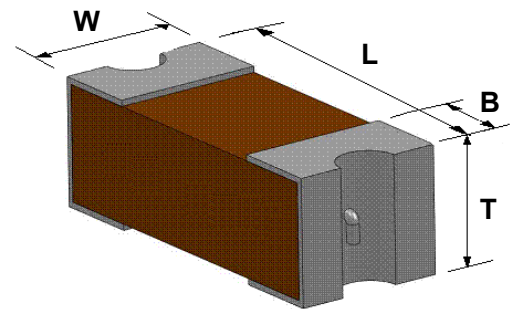

Agency Approval:

Recognized Under the Components Program of Underwriters Laboratories. File Number: E232989

AirMatrix® Surface Mount Fuses

AF Series, 1206 Size

Ordering Information:

Part Number	Current Rating (A)	Marking (White)	Voltage Rating (VDC)	Interrupting Rating	Nominal DCR (Ω)	Nominal I ² t (A ² s)
AF1206F1.50TM	1.50	G	65	50A@65VDC	0.050	0.37
AF1206F1.60TM	1.60	T			0.043	0.52
AF1206F2.00TM	2.00	I			0.032	0.88
AF1206F2.50TM	2.50	J			0.028	1.1
AF1206F3.00TM	3.00	K			0.022	1.9
AF1206F3.15TM	3.15	V			0.020	2.2
AF1206F3.50TM	3.50	L			0.018	2.6
AF1206F4.00TM	4.00	M			0.016	3.3
AF1206F5.00TM	5.00	N	32	50A@32VDC	0.013	5.4
AF1206F6.30TM	6.30	O			0.010	8.9
AF1206F7.00TM	7.00	P			0.0092	10.4
AF1206F8.00TM	8.00	R			0.0084	13.5
AF1206F10.0TM	10.0	Q			0.0050	11.2
AF1206F12.0TM	12.0	X			0.0041	15.0
AF1206F15.0TM	15.0	Y			0.0035	24.5

1. Resistance is measured at $\leq 10\%$ of rated current and 25°C ambient.
2. Melting I²t is calculated at 0.001 second pre-arcing time.

AirMatrix[®] Surface Mount Fuses

AF Series, 1206 Size

Average Pre-arcing Time Curves:

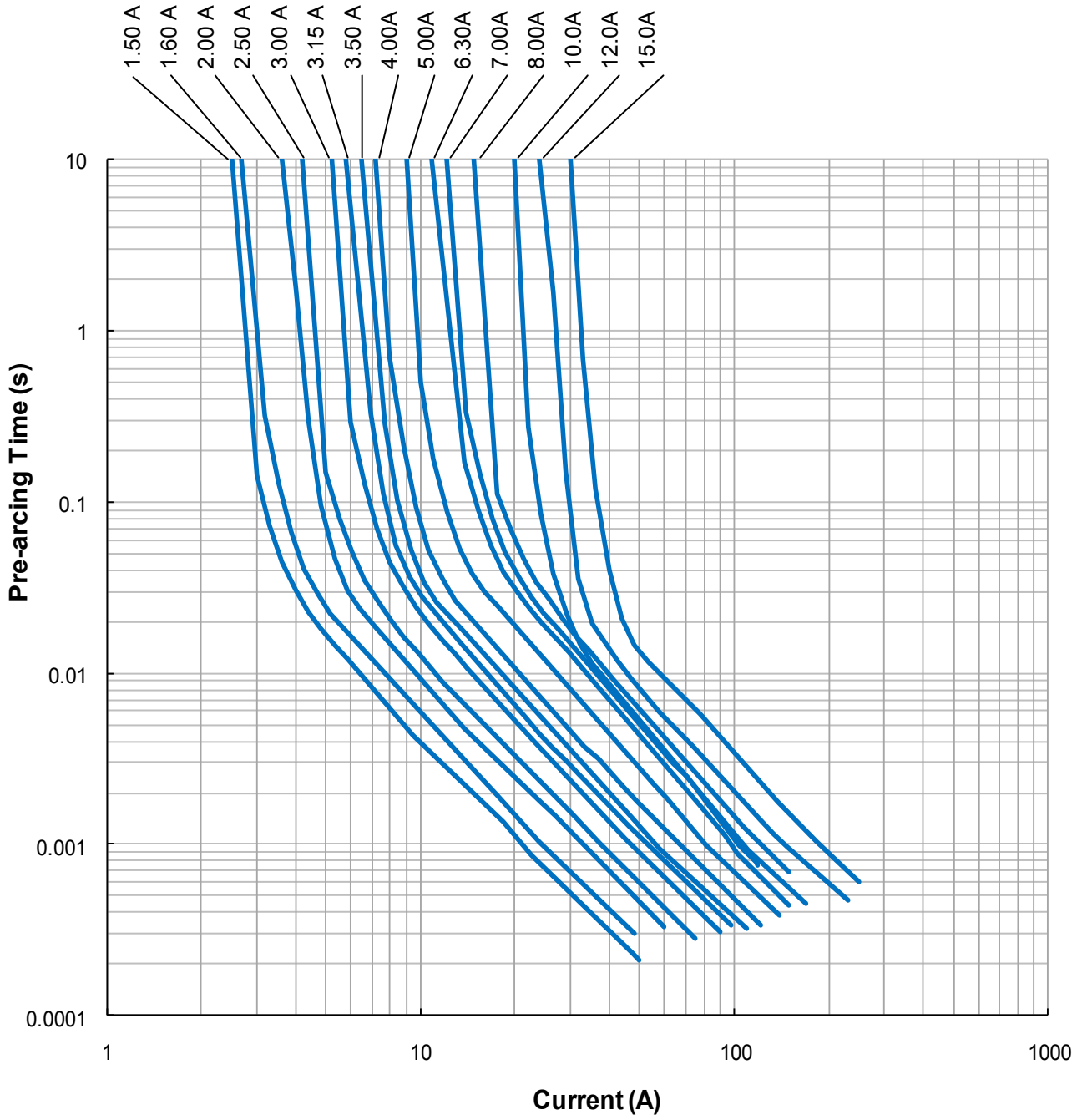

AirMatrix[®] Surface Mount Fuses

AF Series, 1206 Size

Average I^2t vs. t Curves:

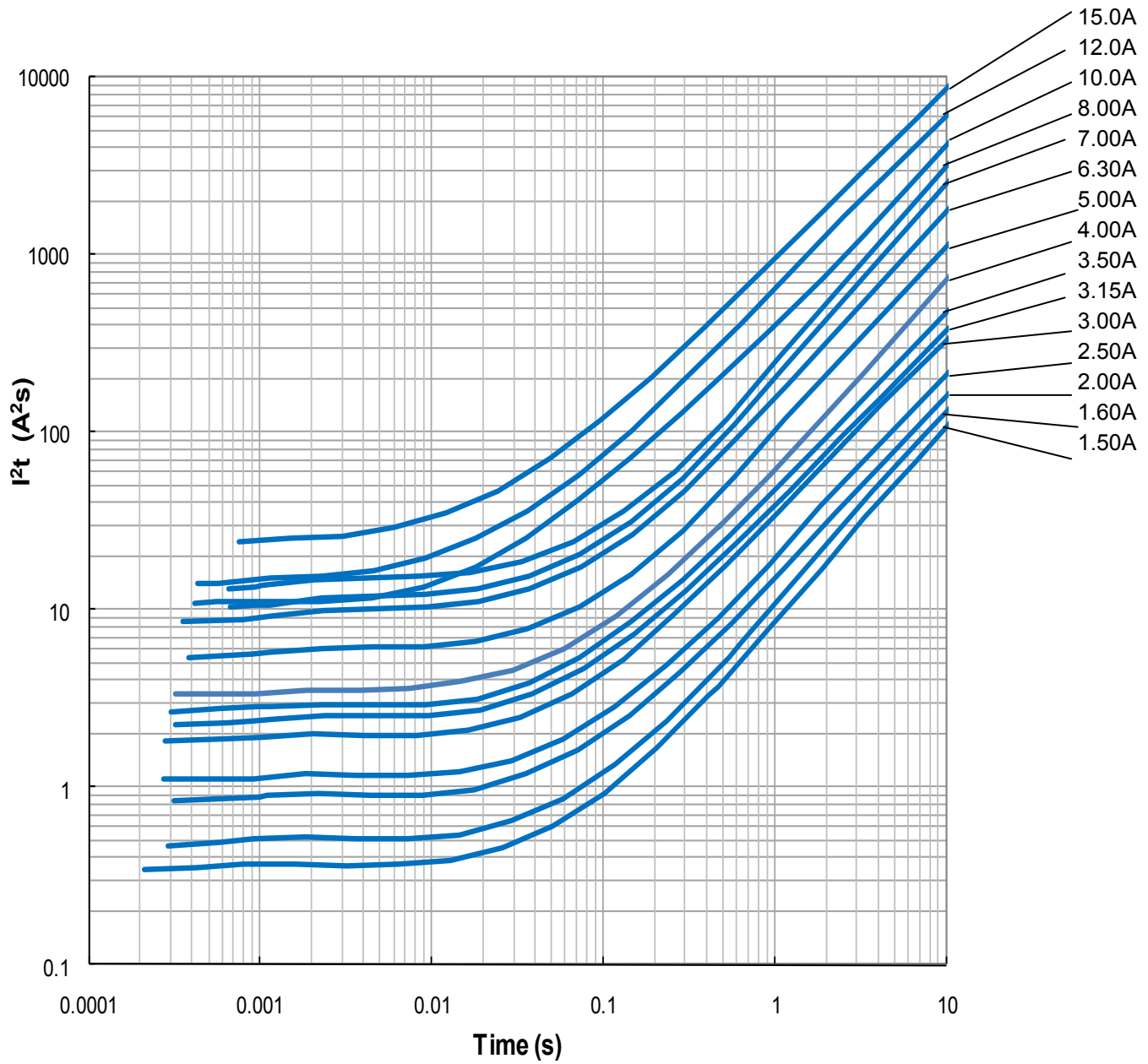

AirMatrix® Surface Mount Fuses

AF Series, 1206 Size

Product Identification:

AF 1206 F 2.00 I M

(1) (2) (3) (4) (5) (6)

(1) Series code: AF

(2) Size code: 1206

(3) Time/Current characteristic: F

(4) Current rating: 2.00 — 2.00A

(5) Package code:

T - Tape & Reel

B - Bulk

(6) Marking code: M - with mark

Environmental Tests:

Reliability Test	Test Condition and Requirement	Test Reference
Reflow & Bend	3 reflows at 245°C followed by a 2 mm bend, 20% DCR change max., no mechanical damage	Refer to AEM QIQ034 , QIQ048
Solderability	245°C, 5 seconds, new solder coverage 90% minimum	MIL-STD-202 Method 208
Soldering Heat Resistance	260°C, 10 seconds, 20% DCR change max. new solder coverage 75% minimum	MIL-STD-202 Method 210
Life	25°C, 2000 hours, 80% rated current, voltage drop change ≤ ±20%	Refer to AEM QIQ106
Thermal Shock	-65°C to +125°C, 100 cycles, 10% DCR change max., no mechanical damage	MIL-STD-202 Method 107
Mechanical Vibration	5 – 3000 Hz, 0.4 inch double amplitude or 30 G peak, 10% DCR change max., no mechanical damage	MIL-STD-202 Method 204
Mechanical Shock	1500 G, 0.5 milliseconds, half-sine shocks, 10% DCR change max., no mechanical damage	MIL-STD-202 Method 213
Salt Spray	5% salt solution, 48 hour exposure, 10% DCR change max., no excessive corrosion	MIL-STD-202 Method 101
Moisture Resistance	10 cycles, 15% DCR change max., no excessive corrosion	MIL-STD-202 Method 106

AirMatrix[®] Surface Mount Fuses AF Series, 1206 Size

Soldering Temperature Profile:

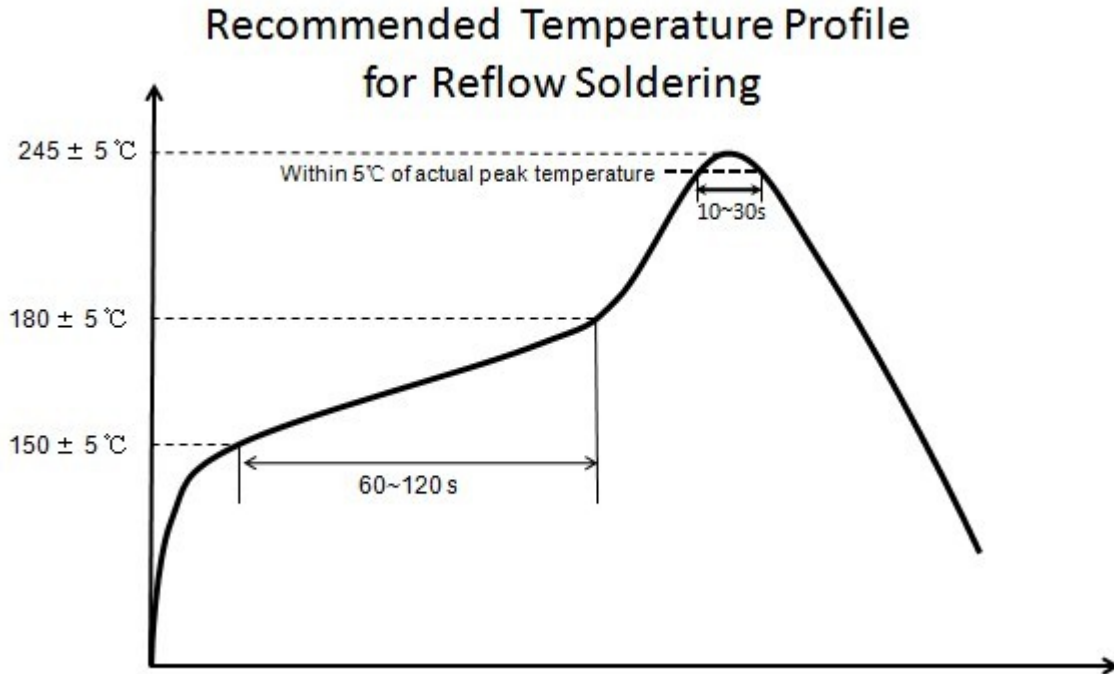

Fuse Selection and Temperature De-rating Guideline:

The ambient temperature affects the current carrying capacity of fuses. When a fuse is operating at a temperature higher than 25°C , the fuse shall be "de-rated".

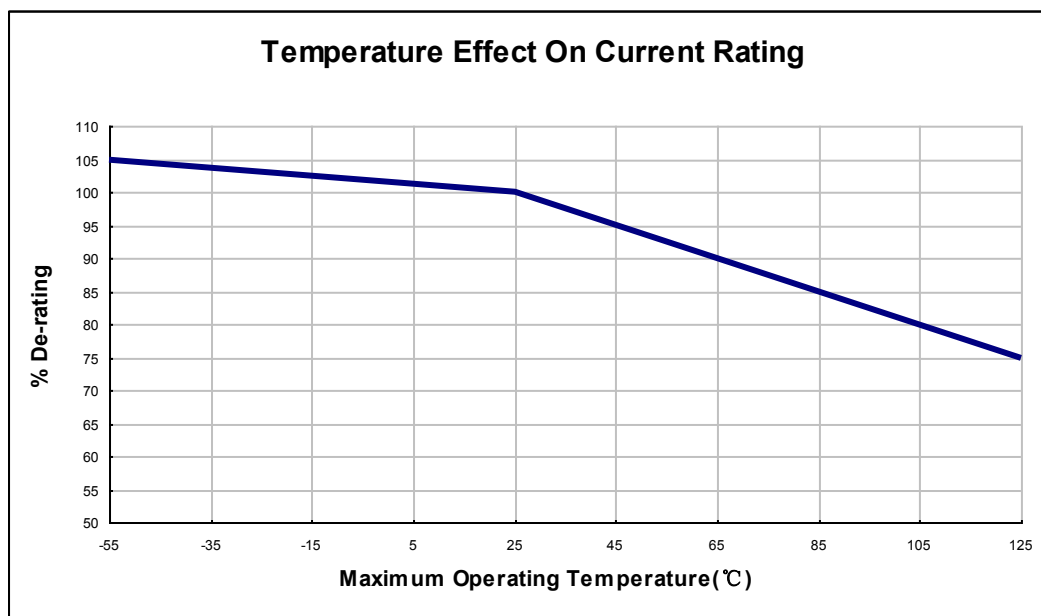

AirMatrix[®] Surface Mount Fuses

AF Series, 1206 Size

Packaging:

AEM's multilayer components are provided on tape-and-reel for use in pick-and-place machines or in bulk for special applications.

Dimensions of Tape in Inches (mm)

Size	A _o	B _o	K _o	Type
1206 (3216)	0.081 ± 0.004 (2.05 ± 0.10)	0.138 ± 0.004 (3.50 ± 0.10)	0.051 ± .004 (1.30 ± 0.10)	Plastic

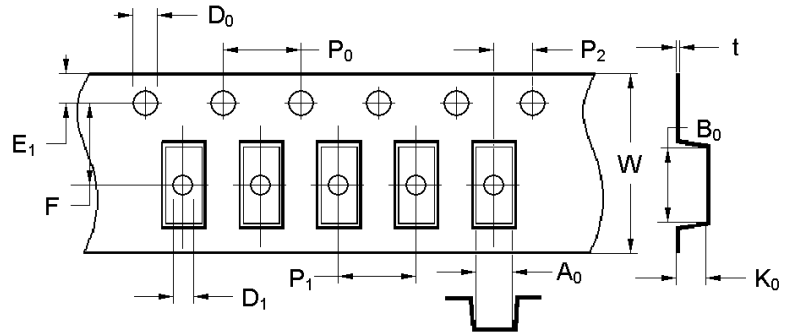

Size	E ₁	F	W	P ₁	P _o	P ₂	D _o	D ₁	t
1206 (3216)	0.069 ± 0.004 (1.75 ± 0.10)	0.138 ± 0.002 (3.50 ± 0.05)	0.315 ± 0.004 (8.00 ± 0.10)	0.157 ± 0.004 (4.00 ± 0.10)	0.157 ± 0.004 (4.00 ± 0.10)	0.079 ± 0.002 (2.00 ± 0.05)	0.059 + 0.004/- 0.00 (1.50 + 0.10/- 0.00)	0.039 ± 0.002 (1.00 ± 0.05)	0.009 ± 0.002 (0.22 ± 0.05)

Chip Size Inch (mm)	Parts on 7 inch (178 mm) Reel
1206 (3216)	3,500

Recommended Land Pattern:

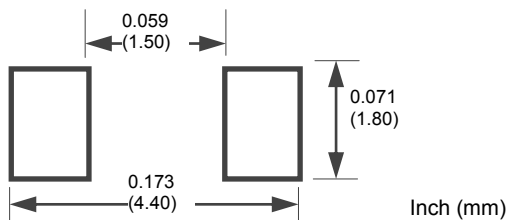

Storage:

The maximum ambient temperature shall not exceed 35°C . Storage temperatures higher than 35°C could result in the deformation of packaging materials.

The maximum relative humidity recommended for storage is 75%. High humidity with high temperature can accelerate the oxidation of the solder plating on the termination and reduce the solderability of the components.

Sealed vacuum foil bags with desiccant should only be opened prior to use.

The products should not be stored in areas where harmful gases containing sulfur or chlorine are present.